

# Vesconite and Vesconite Hilube

## Pump Bearing Design Manual



- Long life
- Low friction
- No swell

# Contents

Page

**Superior pump bearing materials** ..... 1

**Fitting your pump – summary examples** ..... 2

**Vesconite vs other pump bearing materials** ..... 3

**Vesconite - ideal for pump bearings** ..... 4

**Vesconite and Vesconite Hilube fitted to your pump**

    Vertical spindle / mixed flow turbine pumps ..... 8

    Vertical spindle sump pumps ..... 10

    Centrifugal pumps ..... 11

    Archimedes screw pump & other ..... 12

**Technical design**

    Size calculations and typical properties ..... 14

    Designing for dirty conditions ..... 16

    Dry running of pumps ..... 16

    Securing pump bearings ..... 17

    Housings and shafts ..... 18

    Machining tolerances ..... 19

**Chemical resistance chart** ..... 20

**Stock availability** ..... 21

**Technical enquiry form and request for quotation**

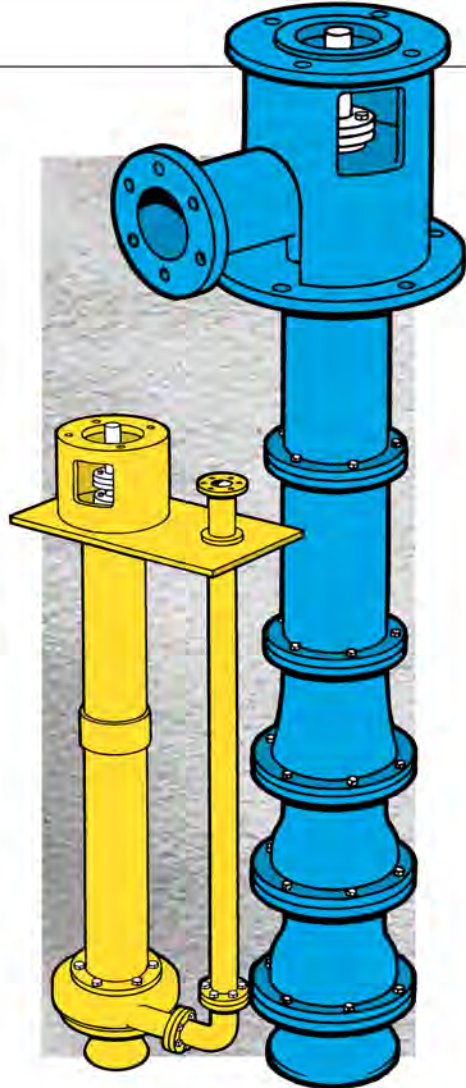

## VescoPlastics company profile

The development of **Vesconite** by VescoPlastics began in 1968 in an attempt to find a plain bearing material suitable for use in exceptionally harsh, dirty and wet conditions found in the surrounding ultra deep mines.

**Vesconite Hilube** was developed later to enhance the performance of standard Vesconite.

**Hitemp 150** was developed as a material resistant to higher temperatures and abrasive conditions.

Today VescoPlastics is a supplier of low friction, long life, low wear bearing materials, supplied to many industries in over 90 countries worldwide. Industries include pumps, railways, mining, heavy transport, earthmoving and marine.

VescoPlastics consists of a dedicated manufacturing plant including extrusion and injection moulding facilities as well as a well equipped machine shop experienced in

machining Vesconite to finished bearing sizes and tolerances. Manufacturing processes are controlled by strict quality standards that ensure products that are consistent in properties and size. The company is ISO 9001:2000 certified.

VescoPlastics has many years experience of bearing applications in many critical industries and is able to advise customers on specific application requirements.

## What is Vesconite?

Vesconite and Vesconite Hilube are specialized plain bearing materials made from internally lubricated low friction polymers.

Vesconite bearings give excellent wear in harsh, wet, dirty or unlubricated conditions.

Vesconite and Vesconite Hilube have many

advantages over traditional bearing materials such as bronze, acetal, nylons, nitriles, rubbers, elastomers, phenolics and laminates, (whether dry or lubricated).

### Vesconite

#### – low friction, long life, well proven

The internally lubricated long life bearing material that has been proven in thousands of critical applications. Originally developed to overcome bearing problems caused by water swell of traditional non-metallic bearing materials. Vesconite is ideal for water lubricated bearings.



### Vesconite Hilube

#### – lowest friction, longest wear life, lowest shaft wear

The advanced grade of Vesconite with a lower friction, lower wear rate and a greater ability to run dry.

Vesconite Hilube has the same dimensional stability, mechanical properties and chemical resistance as Vesconite.

Vesconite Hilube is an ideal bearing material for pump bearings that may experience dry running or in dirty water.



### Hitemp 150

#### – high temperature, abrasion resistant

A low wear bearing material specially formulated for higher temperature resistance, Hitemp 150 can run at elevated temperatures up to 150°C (300°F).

Hitemp 150 also has exceptional abrasion resistance and is well suited to pump applications of media with suspended dirt particles.

Hitemp 150 may be the material of choice when corroded or rough shafts cannot be avoided or in highly silted pump applications where clean water lubrication cannot be provided.



## Fitting your pump – Summary examples

Vesconite and Vesconite Hilube offer significant advantages in a number of pump applications.

### Vertical spindle turbine pumps

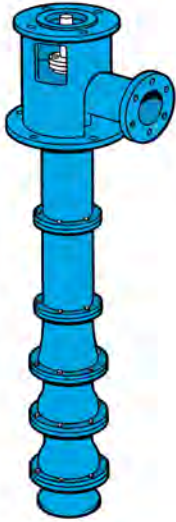

#### Top stuffing box bearings

- Vesconite Hilube is ideal for dry start up conditions
- Closer running clearances mean reduced seal wear

#### Lineshaft and pump bowl bearings

- Long life
- Can be lubricated with process water temporary/short term as well as oil
- Vesconite Hilube able to survive dry running
- Closer running clearances means less shaft run out and less vibration

#### Suction cover bearings

- Good wear life even in dirty conditions
- Can be lubricated with process water rather than a dedicated grease or oil supply

### Vertical spindle sump pumps

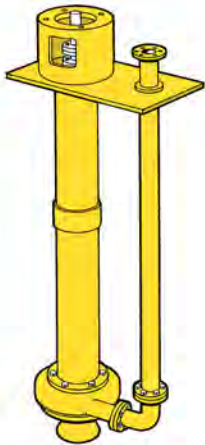

#### Shaft support bearings

- Can be lubricated with water or process fluids as well as grease or oil
- Able to survive temporary suspension of lubrication during start up or pump snoring

#### Impeller support bearings

- Close running clearances
- Low wear
- Can run dry for short periods

#### Wear rings

- Close running clearances improve pump efficiency

### Centrifugal pumps

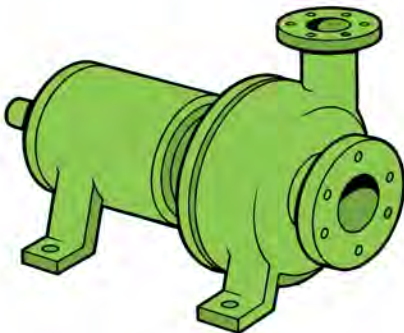

#### Support bearings

- Low wear rate
- Closer clearances give a stable shaft and lower seal wear

#### Lantern rings

- Low friction gives ability to survive temporary suspension of lubrication water
- Good dimensional stability allows for closely defined clearances to regulate water flow

#### Impeller and casing wear rings

- Low friction and low water swell allows smaller running clearances giving better pump efficiency

# The advantages of Vesconite compared to other materials

## Bronze

Bronze must be lubricated to operate. Even when greased, bronze has a higher friction than Vesconite dry or ungreased.

Internally lubricated Vesconite has a lower friction than bronze with grease. Vesconite can even run dry.



## Elastomers

Elastomers lack dimensional stability - they absorb water and have a high thermal expansion. Larger clearances must be used resulting in more unstable shafts and a reduction of the allowable wear life.

Vesconite does not swell in water and has a higher load capacity than elastomers. No stress relief during machining.



## Laminates & composites

Laminated materials tend to absorb water with the potential to swell and delaminate. Laminates materials can result in high shaft wear and a noisy operation.

Vesconite is a homogenous material with no water swell and no chance of delamination. Vesconite bearings are quiet with reduced shaft wear.



## Rubber

Rubber bearings have high friction and exhibit stick-slip. This results in high shaft wear and shaft vibration.

Rubber must be lubricated and swells in water.

Vesconite bearings carry a higher load than rubber and the low friction gives a low shaft wear and no stick-slip.

Vesconite is easily machined to accommodate variable shaft and housing sizes.

# Why Vesconite and Vesconite Hilube are ideal for pump bearings

- Low friction
- Low shaft wear
- Easy to install and remove
- High compression strength
- Resistant to chemicals
- Negligible water swell
- Safe and health
- Able to run dry
- No delamination
- Drinking water approval
- Low thermal expansion
- Environmentally friendly
- Easy to machine

## Self lubricating

Vesconite is internally lubricated with advanced internal lubricants that are compounded as part of the material. This gives Vesconite a low friction even in the absence of additional lubrication. Low friction means low wear.

## Low friction

Vesconite has a low coefficient of friction. Even when lubrication or water is not present.

Stick-slip does not occur with Vesconite bearings even if pumps have been in standby mode for long periods of time without operating. This can reduce the requirement to prime bearings before starting a pump. This is critically important for emergency type pumps such as fire pumps, settler pumps and flood pumps.

## Able to run dry

Pump bearings often need to withstand dry running for short intervals, for example at start up or if the pump inlet becomes blocked. Vesconite and Vesconite Hilube's internal lubricants give them a very low friction even when lubrication is not present.

Vesconite survives dry run conditions without damaging the bearing.

Many bearing materials operate well under well lubricated situations, but fail when lubrication is not present.

## No water swell

Vesconite does not swell or soften in water, whereas most synthetic materials swell in water. Vesconite bearings can be machined accurately to size and maintain these sizes even when immersed.

To compensate for the water swell and to avoid the risk of seizures, excessive clearances are used. With Vesconite, close clearances can be maintained, reducing vibration and shaft run out. Large clearances should be avoided because:

- Bearing wear rate increases
- Bearing life is shortened
- Shaft vibration increases, making the shaft less stable.

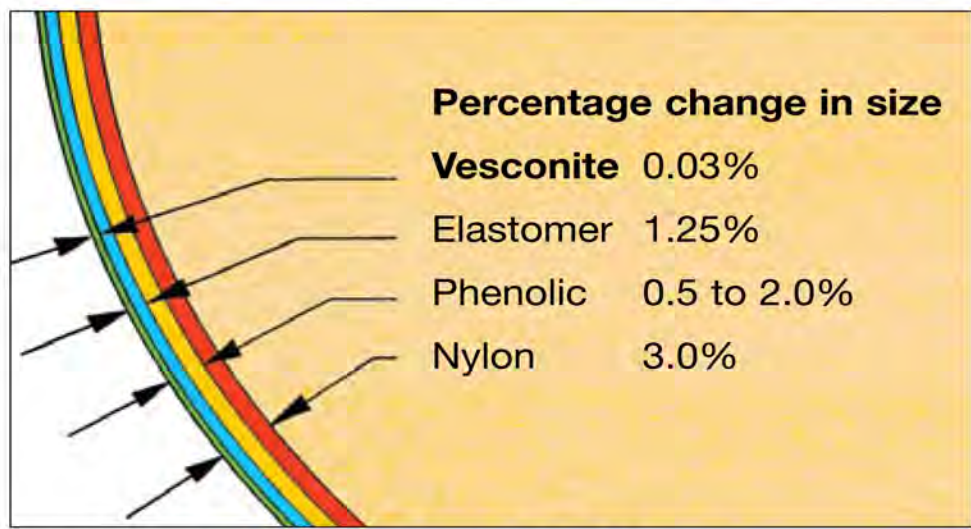

Swell of synthetic bearing materials due to water

## Drinking water approval

Vesconite and Vesconite Hilube have undergone extensive testing and have been approved by an independent water quality authority for hot and cold drinking water applications.

Vesconite bearings can be used in continuous full contact drinking water applications.



**WRAS**  
Water Regulations Advisory Scheme

**EU Approved**

Our Ref: CRJ/C

16 July 2007

Vesco Plastics  
PO Box 40647  
Cleveland  
Denver 2022  
Gauteng  
South Africa

Dear Sir

**ITEMS WHICH HAVE PASSED FULL TESTS OF EFFECT ON WATER QUALITY - BS 6841**

We refer to your application for the material(s) described below to be approved arising from the results of the tests of effect on water quality that have been carried out on the product(s) so described. It has been decided that there is no objection to its/their use provided the source, nature and manufacturing processes of the ingredients and products are not changed. (See notes overleaf).

9172

### MISCELLANEOUS

Vesconite (Grey) and Vesconite Hilube (Cream) material. For cold water and hot water use up to 85°C.

Original Approval No: M104020/A & B

VESCO PLASTICS

0706591

## High compression strength

Vesconite keeps its strength even when wet and does not creep under high loads.

Loads on Vesconite bearings do not result in compression deformation or compression set. This means that the shaft is more stable.

High load capacity Vesconite bearings offer better load capacity than many traditional rubber or elastomer bearings.

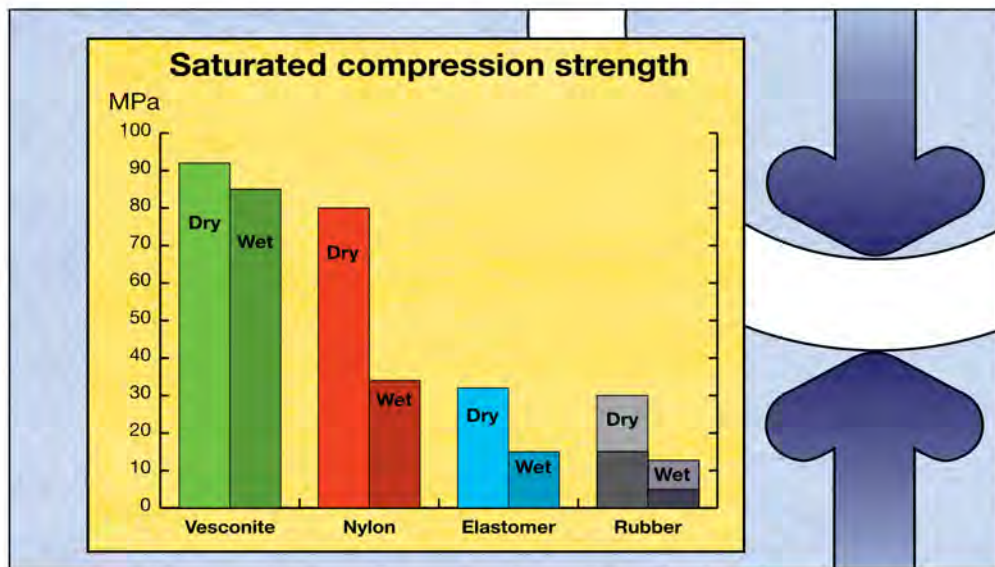

## Low shaft wear

Wear of expensive shafts can be more of a problem than wear of a bearing because of the cost of the shaft. Shaft wear is especially severe in dirty operating conditions.

Appropriately designed hard shafts running in Vesconite bearings exhibit exceptionally low wear. Vesconite Hilube further reduces shaft wear due to its lower friction.

In particular nylons and many rubber materials are noted for damage caused to shafts.

## Easy to install and remove

Vesconite bearings are easy to install and remove without the need for expensive equipment. Bearings can be easily installed on site with a minimum of effort and equipment,

using simple mechanical methods.

Vesconite does not corrode and seize in bearing housings, unlike bronze and metal backed bearings which become difficult to remove.

## Easy to machine

Vesconite can be easily machined on standard metalworking equipment.

Vesconite does not creep, deform or swell and machines easily to desired tolerances.

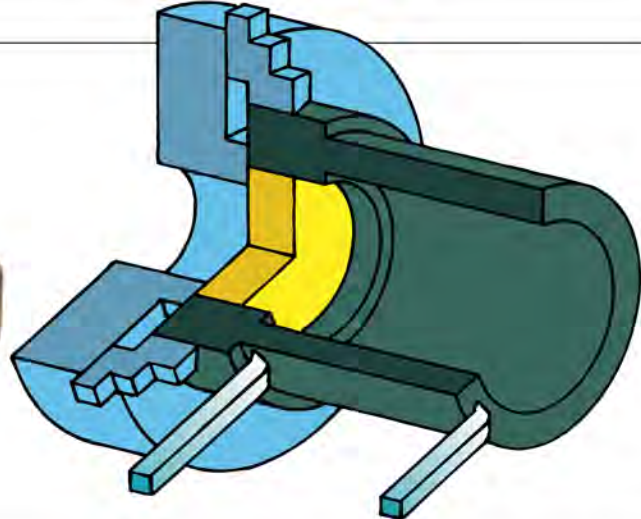

## No delamination

Delamination is the peeling off of layers of a laminated bearing material. This often happens in immersed conditions where water or liquid penetrates the exposed micro-channels that are formed by the cloth reinforcing material.

Swelling occurs along the micro channel surfaces causing stresses between the layers of the laminate, resulting in the layers peeling off.

Vesconite is a homogeneous material with no lamination reinforcement and so does not delaminate.



## Resistant to chemicals

In addition to its excellent performance in water, Vesconite and Vesconite Hilube are resistant to a wide range of chemicals including acids, organic chemicals, solvents, hydrocarbons, oils and fuels.

Page 20 gives a detailed chemical resistance chart.

Vesconite and Vesconite Hilube bearings can therefore be lubricated by a range of pumped media. Mixtures of water, oils and fuels do not damage Vesconite bearings.

## Safety and health

Vesconite does not contain any hazardous substances such as asbestos or fibres that make using, handling and machining unsafe.

Vesconite is an exceptionally clean material to machine and possesses no fibre or dust hazards.



## Low thermal expansion

Vesconite bearings do not change size significantly as the operating temperature changes, so close clearances can be maintained across a wide temperature range.

This means that Vesconite bearings can be designed with minimal running clearances without danger of shaft seizures.



## Vesconite and Vesconite Hilube fitted to your pump

There are many pump designs, each with its own unique demands for its area of operation.

But all pump users require reliable bearings and wear rings. Pumps are often used in critical applications where bearing failure must not

happen as the consequential results could be extremely serious.

Vesconite bearings provide the performance, reliability and long life desired by pump manufacturers and end users in a variety of pump bearing applications.

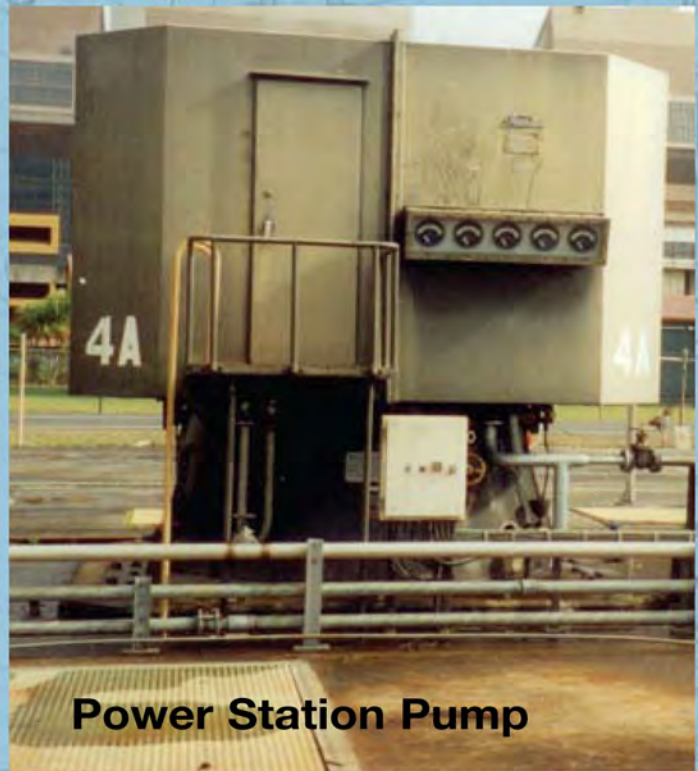
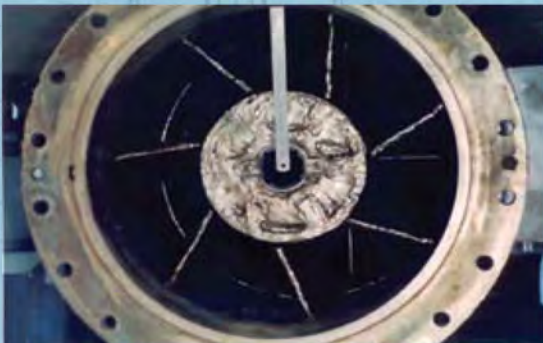

**Power Station Pump**

## Vertical spindle, axial flow, mixed flow, turbine and propellor pumps

These pumps are generally used to pump high volumes of water at low pressure heads, often in critical applications or as emergency standby pumps where reliability and long life are important. Maintenance on these pumps can be difficult and expensive.

Examples include:

- Power station cooling water pumps
- High volume fire fighting pumps
- Top up water pumps
- Submersible bore hole pumps
- Waste water pumps
- River abstraction pumps

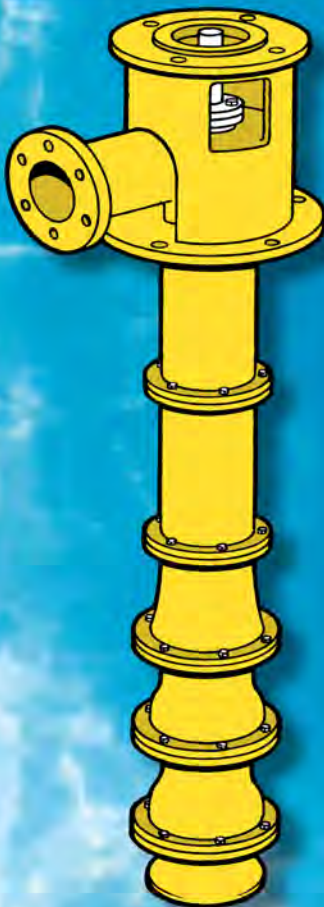

### Stuffing box bearings

Stuffing box bearings lack the water flow experienced by lineshaft bearings. Vesconite bearings offer a low friction and therefore an ability to perform with only a limited water flow.

Vesconite Hilube bearings can survive a dry start up of the pump as well as giving a long bearing life in the absence of lubrication through the bearing.

Water flow through stuffing box bearings can be ensured using a pressure feed line or a low pressure dump line. A lantern ring groove can be added to the bearing to allow a well distributed flow across the bearing.

Vesconite bearings can be manufactured to close running clearances which do not change considerably due to temperature variations. Nor will Vesconite swell so the danger of shaft seizure is avoided.

Because of the closer running clearance, the shaft is more stable. Greater shaft stability and less vibration means that seals and external roller bearings are able to operate more effectively and last longer.

### Lineshaft and pump bowl bearings

Many bearing materials operate adequately when a good water flow is present through the bearing. This flow is not always present on start up or can be interrupted due to a blocked inlet to the pump. This situation is a problem for bearing materials that require an uninterrupted water flow.

The dry running ability of Vesconite allows bearings to survive these conditions with no permanent damage. Vesconite and Vesconite Hilube are internally lubricated with advanced lubricants that give them the ability to withstand a temporary suspension of water lubrication.

Vesconite allows for high precision, long life and reliable product or external feed lubricated bearings.

Vesconite bearings can be lubricated with water or a range of pumped product which limits the requirement for cumbersome oil lubrication systems and the environmental hazard associated with these systems.

Vesconite can be lubricated with oil in the case of oil lubricated pumps.

The internal lubrication and high compression strength of Vesconite allows fewer or shorter bearings to be used.

Closer running clearances ensure more stable shaft operation with less vibration.

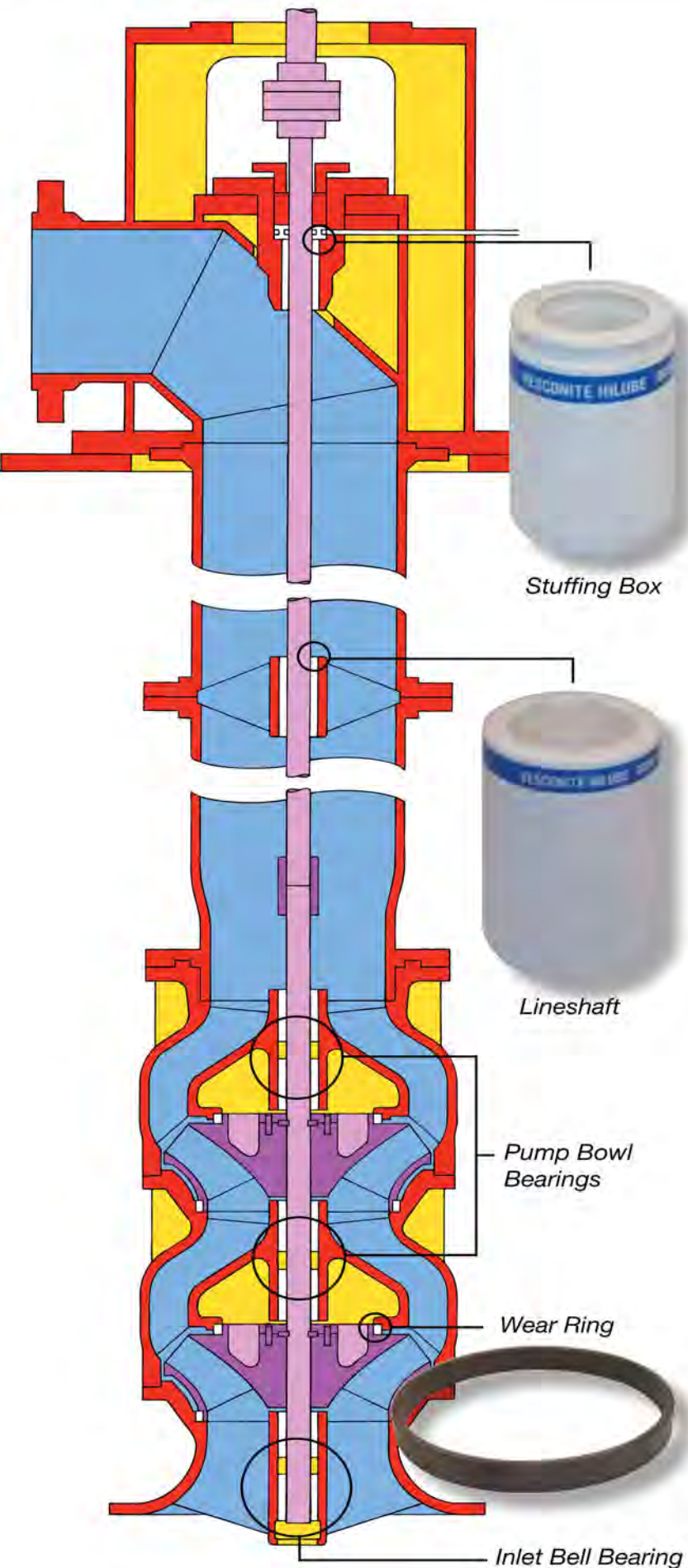

## Suction cover or Inlet Bell bearings

Suction cover bearings usually experience high concentrations of dirt particles from the water source especially in river water applications.

To overcome wear caused by this dirt, suction cover bearings are often sealed and grease or oil lubricated. Grease or oil may be fed from the surface through long lubrication lines along the length of the pump.

In addition to the complex grease or oil lines and the required lubrication system, a big disadvantage is that grease or oil leaking from the bearing contaminates the process water.

Vesconite can be lubricated with process water fed from an upper stage rather than from a dedicated oil or water lubrication system from the surface. Often cumbersome grease lubrication lines and systems can be done away with and grease pollution avoided.

Where suction cover bearings are water lubricated, the upstream side of the bearing is sealed to prevent dirty water from entering the bearing. Water is fed either from an upper stage or from a dedicated supply into the bearing usually using a lantern ring groove in the bearing.

The downstream side of the bearing is open and the water is exhausted into the pump flow.

Where a totally sealed bearing is required, Vesconite can be lubricated with grease or oil.

## Impeller and casing wear rings

Vesconite can be used for efficient impeller and casing wear rings. Due to its self lubricating properties, Vesconite can run with smaller running clearances than metal rings.

Instantaneous contact with the casing or impeller wear ring does not cause damage to the Vesconite or to the mating surface.

The closer running clearance means an efficiency improvement due to a lower by-pass.

## Vertical spindle sump pumps

Sump pumps can be used to pump a variety of fluids including clear water, hot liquids, chemically aggressive fluids and dirty and abrasive liquids with high concentrations of particles or fibres.

Examples include:

- Sump drainage pumps
- Vertical cantilever slurry pumps

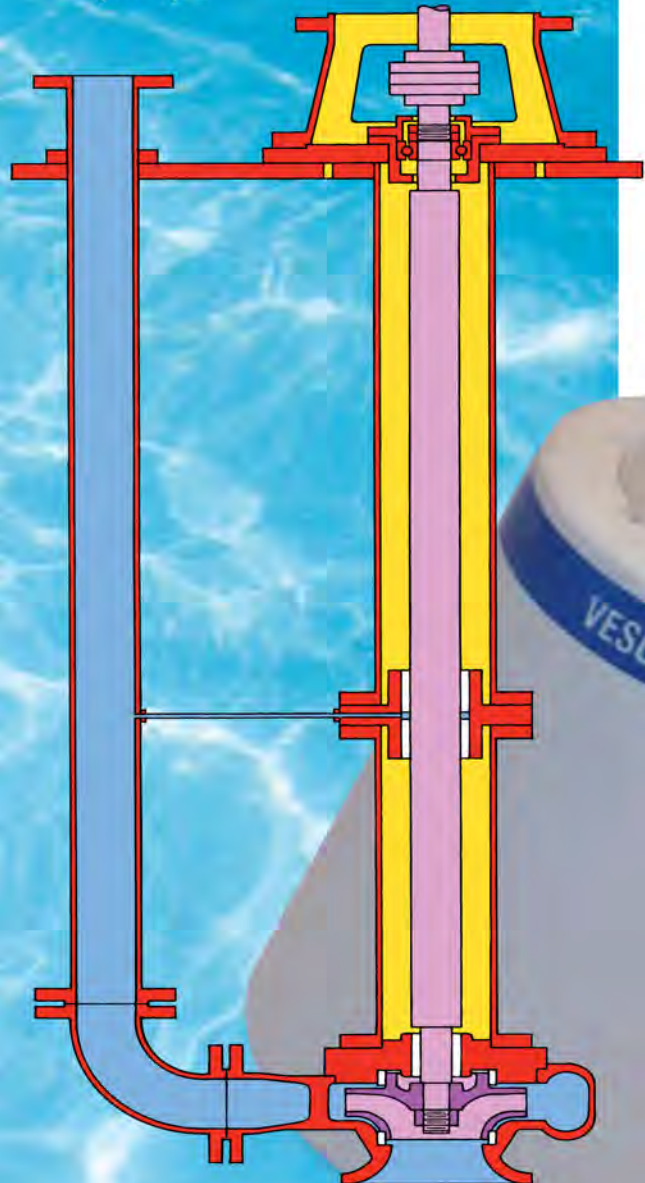

### Intermediate shaft support bearings

When pump shafts are long, intermediate bearings are required to support the shaft. These bearings are often lubricated by dedicated grease supply lines from the surface.

Vesconite shaft support bearings can be lubricated using a dedicated lubrication supply or process water fed from the pump discharge pipe with no need for additional lubrication systems.

Especially on long pumps that are used in a harsh environment, lubrication lines are often broken off at installation or during operation.

Vesconite bearings can be designed with close running clearances. This means a more stable shaft and less shaft run out.

The self lubrication of Vesconite allows successful operation of the bearing even when the water flow from the discharge pipe is temporarily suspended.

The dry running ability of Vesconite reduces the need to prime the pump before start up.

### Impeller support bearings

Impeller support bearings are often fully exposed to the harsh liquids that are being pumped. These bearings are immersed in the medium but lack the flow of lubrication often required by bearing materials.

Vesconite bearings can resist many chemically harsh pumped media.

Where pump snoring occurs, Vesconite's self lubrication allows the bearing to run for a time without damage caused to the shaft or bearing by the lack of lubrication.

Close running clearances allow for stable impeller operation with reduced vibration.

Where the pumped medium is especially dirty or hot and the bearings are not isolated from the media, Hitemp 150 is the material of choice.

Hitemp 150 is a material designed for high temperature applications with the added advantage of good abrasion resistance.

### Wear rings

Vesconite wear rings can be designed with closer running clearances improving the pump efficiency due to a lower bypass.

# Centrifugal pumps

Examples include:

- Multistage mining pumps
- Process pumps
- Slurry pumps
- In line process pumps
- Split case pumps

Some specific applications include:

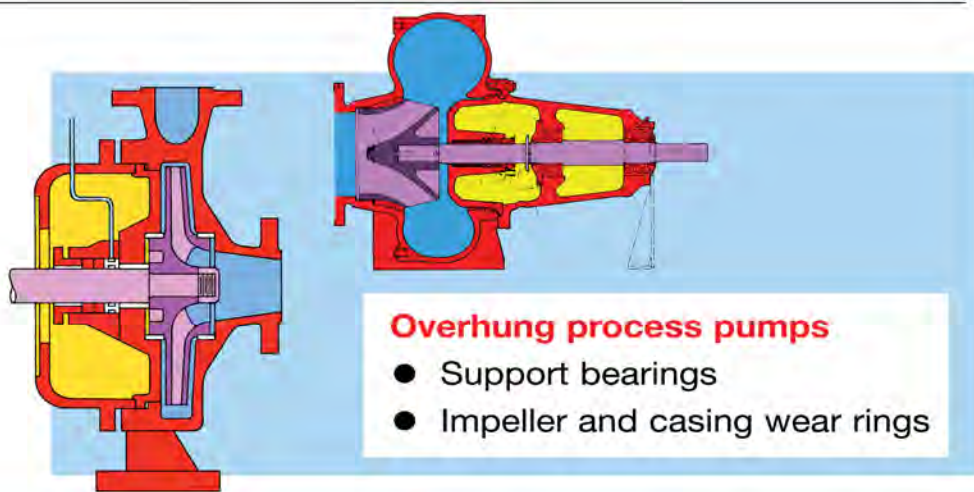

## Overhung process pumps

- Support bearings
- Impeller and casing wear rings

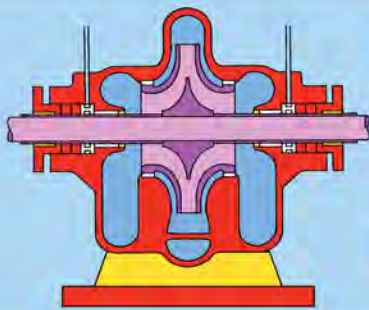

## Split case pumps

- Support bearings
- Lantern rings
- Impeller and casing wear rings

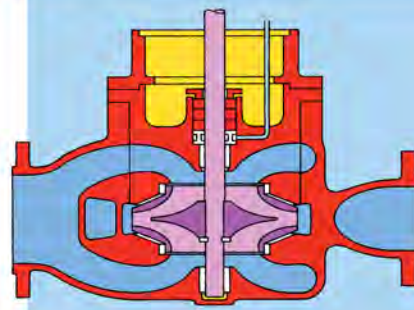

## Vertical in line pumps

- Support bearings
- Impeller and casing wear rings



## Support bearings

Vesconite bearings can be designed with close running clearances reducing shaft vibration and improving external bearing life.

Vesconite long life bearings ensure that expensive removal and repair of pumps is limited.

Support bearings can be grooved bearings when there is a water flow through the bearing. Bearings may not require grooves where the bearing is immersed in the pumped medium and does not require much cooling.

## Lantern rings

Lantern rings are used as part of a shaft sealing system to evenly distribute water around the pump shaft and are used especially in slurry pumps.

The dimensional stability of Vesconite allows for stable running clearances so that a desired water flow rate may be achieved. Due to their low friction, Vesconite rings can survive even when the water supply is temporarily suspended.

## Impeller and casing wear rings

Vesconite wear rings can be designed to run with smaller clearances between the ring and impeller or casing. This means a higher pumping efficiency due to a lower bypass.

If the Vesconite wear ring happens to contact with the housing no damage is caused. The wear ring will conform to the new size and re-establish a close clearance.



## Archimedes screws

### Water lubricated end support and intermediate bearings

Flushed Vesconite bearings perform well even in harsh chemical or dirty environments. Vesconite's high loading capacity coupled with low friction gives low wear rate bearings.

Vesconite can be flushed with water rather than lubricated with environmentally polluting oils and greases.

Bearings are usually grooved to ensure an adequate flow of water through the bearing.

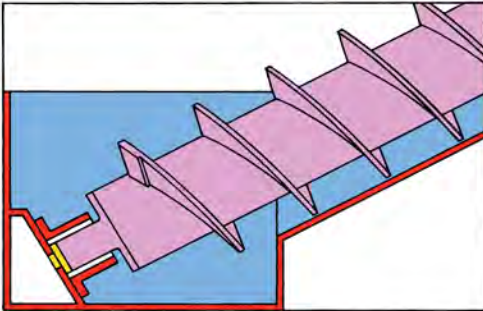

## Air vane motors

Vesconite vanes show good wear life in many applications, are not easily damaged or cracked unlike carbon vanes and are resistant to a variety of pumped media.



## Gear pumps

### Pump bodies and gears

The dimensional stability, good resistance to a variety of chemicals and low wear rate make Vesconite well suited to pump bodies and pump gears.

### Support bearings

The low friction, long life properties of Vesconite give a long life for support bearings.

The low friction of Vesconite Hilube allows successful operation even when running dry for a short time.

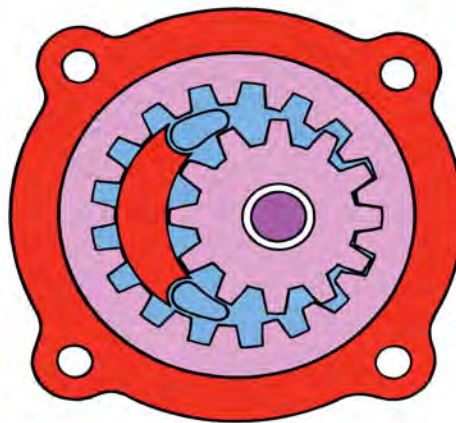

Internal gear pumps

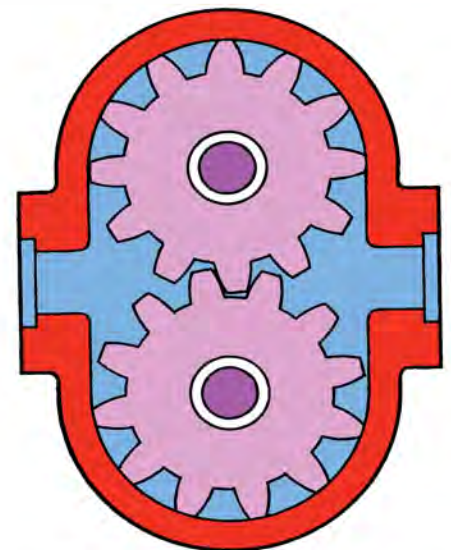

External gear pumps

## Other immersed applications

Aerators, thickeners, mixers, ship stern tubes and rudders, hydroelectric turbines and flow gates all benefit from using Vesconite bearings.

Vesconite does not swell in water and therefore can maintain close running clearances without the danger of seizure in many immersed applications.

Vesconite has a very low wear rate especially when lubricated with water. This reduces maintenance on many of these difficult to maintain applications.

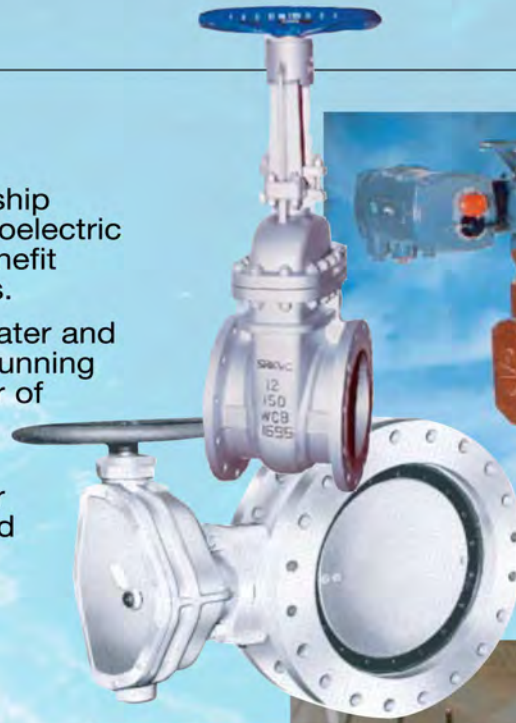

**Valves**

## Hydro Power

- Wicket gate bearings
- Turbine bearings

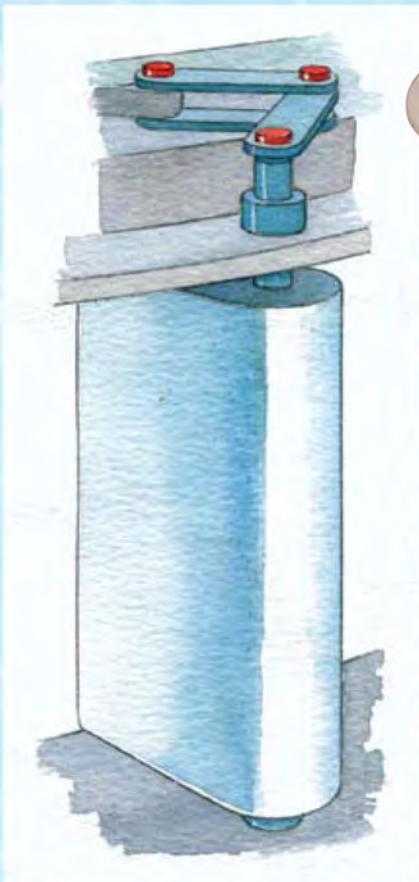
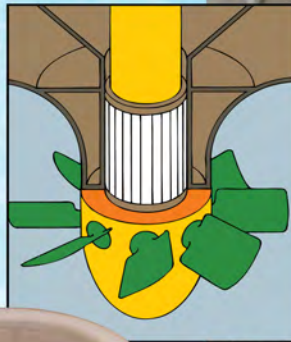

## Marine

- Rudder
- Stern tube bearings



# Design

## Vesconite and Vesconite Hilube Size Calculations



The easiest way to dimension Vesconite bearings is to use the internet online *Design a Bearing* calculators on [www.vesconite.com](http://www.vesconite.com).

Within seconds *Design a Bearing* gives the correct interference fits, running clearances, groove sizing and tolerances across a wide range of operating temperatures.

The standard design calculations for the use of Vesconite and Vesconite Hilube in pump applications are given below from first principles. These calculations are for free standing bushes before installation.

The same equations apply to both Vesconite and Vesconite Hilube.

The most common method for securing a Vesconite bearing. Calculated as:

$$\text{Press fit} = 0.05 + (0.002 \times \text{housing } \varnothing) \text{ mm}$$

$$\text{Press fit} = 0.002'' + (0.002 \times \text{housing } \varnothing) \text{ inches}$$

### Interference fits/ Press fits

### Bore closure

The closure of the inside diameter when a bearing is pressed into a housing is called the bore closure.

$$\text{Bore closure} = \text{press fit} \times \frac{\text{housing diameter}}{\text{shaft diameter}}$$

### Assembly clearance

This is the difference in diameter between the bearing inside diameter and the shaft after installation.

$$\text{Assembly clearance} = 0.05 + (0.02 \times \text{wall thickness}) \text{ mm}$$

$$\text{Assembly clearance} = 0.002'' + (0.02 \times \text{wall thickness}) \text{ inches}$$

### Calculation of the bearing dimensions

$$\text{Outside diameter} = \text{housing diameter} + \text{total press fit}$$

$$\text{Inside diameter} = \text{shaft diameter} + \text{bore closure} + \text{assembly clearance}$$

## Typical properties of Vesconite and Vesconite Hilube

Properties	Metric	Imperial
Maximum design load (static, oscillating or occasional movements)	30 MPa	4,250 psi
Linear expansion due to moisture at 65% relative humidity	0.04%	0.04%
Linear expansion due to moisture - saturated	0.07%	0.07%
Guide maximum operating temperature	Immersed	65°C
	Dry or grease / oil lubricated	100°C
Thermal coefficient of expansion	$6 \times 10^{-5} \text{ mm/mm/}^\circ\text{C}$	$3.3 \times 10^{-5} \text{ in/in/}^\circ\text{F}$
Density / specific gravity	1.38 g/ml	1.38
Modulus of elasticity	2.2 GPa	493 000 psi



## Temperature rating of Vesconite

Typically Vesconite and Vesconite Hilube are limited to 65°C (149°F) in immersed conditions and 100°C (212°F) in dry conditions. For higher operating temperatures, please contact VescoPlastics with details of your application. Hitemp 150 is designed for immersed temperatures of up to 125°C (250°F) and 150°C (300°F) in dry conditions.

Correct bearing design is essential to long life bearing operation. Different bearing materials have different criteria for design.

Vesconite and Vesconite Hilube are superior bearing materials. However, if these materials are designed incorrectly, premature bearing failure may occur.



## Grooving of bearings

Many pump bearings require effective cooling of the bearing surface because of the frictional heat generated by high rotational speeds. Pump bearings often require cooling by either process fluids or dedicated lubrication systems through correctly designed grooves.

### Straight, axial or longitudinal grooves

Generally straight grooves are used for lineshaft bearings on vertical turbine pumps. The pumped medium passes through the axial grooves to provide a constantly refreshing cooling film.

It is important that these bearings are not greased as the grease may block the channels. This will limit the water flow through the bearing, possibly leading to overheating of the bearing.

## Typical groove design

Shaft diameter		No. of grooves	Size - mm		Size - inches		Water flow rate	
mm	inches		width	depth	width	depth	l/min <sup>-1</sup>	gal/min <sup>-1</sup>
20-30	1 – 1½	3	6	2.5	0.25	0.1	4	1.0
31-50	1½ – 2	4	8	3	0.30	0.125	8	2.0
51-80	2 – 3	6	8	3	0.30	0.125	12	3.0
81-120	3 – 5	6	10	3.5	0.40	0.15	18	4.5
121-160	5 – 7	8	12	4	0.50	0.20	24	6.0
161-200	7 – 8	10	12	4	0.50	0.20	30	8.0

## Groove shape and depth

Grooves should preferably be greater than 2.5 mm (0.1”) deep to avoid blockages by sand or coarse debris. As a general rule the depth of grooves should be less than half the wall thickness of the Vesconite bearing.

**When a thin wall thickness limits groove depth, extra grooves can be added to ensure adequate flow.**



### Wall thickness

It is generally recommended that the wall thickness should be between 5 - 20% of shaft diameter.

For thinner Vesconite bearings, care is required when machining and fitting to avoid cracking. Bonding and mechanical securing can be used to ensure that the bearing is properly secured.



### Designing for dirty conditions

Suspended dirt particles significantly increase wear of all bearing materials and cause wear to expensive shafts. This is a common problem especially on pump suction cover bearings when pumping dirty river or process water.

To overcome this problem, suction cover bearings are often sealed and lubricated with grease or oil from a dedicated supply.

But this additional system is cumbersome and is prone to damage especially during pump installation or removal.

It may cause environmental problems, especially if there is an oil leak.

In dirty conditions, Vesconite can be lubricated with:

- i) **Process water.** Use a feed from an upper stage.
- ii) **Clean water feed.** This is advised when the pumped medium is very dirty.
- iii) **Grease or oil.** Vesconite performs well with oil or grease lubrication.

In dirty conditions use Vesconite Hilube bearings with suitably hardened shafts for low wear rate and reduced shaft wear.



### Dry start and running of sump pump bearings

Pump bearings generally require a lubrication film to remove the heat resulting from the high sliding speeds and bearing loading. Water or other pumped media is drawn through the grooves and over the bearing surface to provide effective cooling.

Traditional bearing materials operate acceptably as long as this cooling flow is present. This flow can easily be interrupted during start up conditions or due to blocked inlets, causing bearing damage or even leading to failure and pump downtime.

Vesconite is internally lubricated giving a low friction which allows the bearing to cope with high loads and speeds.

The internal lubricant of Vesconite Hilube gives a very low friction and a greater ability to deal with these conditions.

At start up, typical vertical spindle pumps may require the upper lineshaft bearings and the stuffing box bearing to run dry for a time before water reaches the bearing. Pump priming is usually difficult.

Tests have been conducted on Vesconite Hilube bearings to determine their ability to run dry under typical pump operating conditions. Vesconite Hilube survived for well over one minute without bearing damage.

This is far better than alternative water lubricated pump bearing materials, many of which melt down or burn within seconds.

Pumps operating with Vesconite or Vesconite Hilube do not require pre-lubrication of the bearings and can run dry for a time without the danger of bearing damage.



- **Fire Fighting Pumps**
- **Dewatering Pumps**
- **Flood Pumps**

# Securing pump bearings

## Interference fits

Using an interference fit is the easiest method to secure a Vesconite bearing when the bearing operates at temperatures up to 70°C (160°F).

Vesconite is a rigid material and may be easily secured with an interference fit without the need for additional methods.

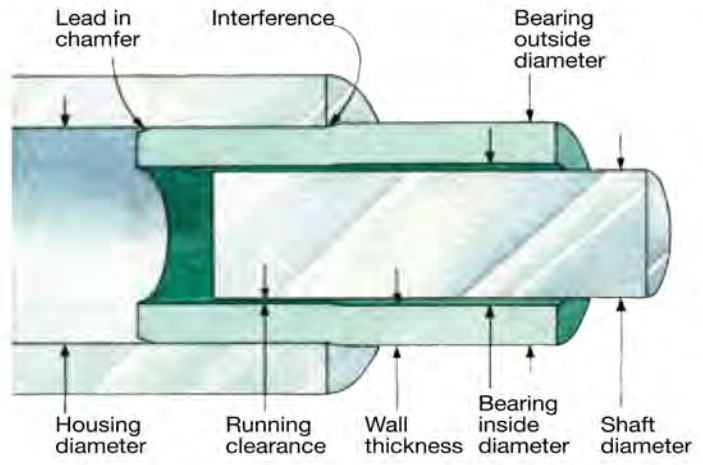

## Fitting bearings

Fitting and removal of Vesconite bearings is easier than metal backed bearings.

**Press fitting:** Vesconite bearings can be fitted using mechanical or hydraulic presses. Care needs to be taken that the bearing is fitted square to the housing and is well supported, preferably with a mandrel.

Lead in chamfers on the Vesconite bearing and the metal housing ensure that the bearing will not be scored during installation.

Diameter		Chamfer @ 30°	
mm	inches	mm	inches
10 - 20	1/2 - 1	0.5	0.02
20 - 50	1 1/2 - 2	1	0.04
50 - 100	2 - 4	1.5	0.06
100 - 250	4 - 10	2	0.1
>250	> 10	3	0.15

**Freeze fitting:** Freeze fitting greatly helps with installation of long bearings, large bearings and bearings with thin walls.

**Use a freezer (-40°C, -40°F)**

**Dry Ice:** Pack the bearing on the inside and outside with dry ice in an insulated container.

**Liquid Nitrogen:** Take care to ensure that the bearing does not come into direct contact with the liquid nitrogen.

Do **NOT** heat the bearing housing to aid installation as this may damage the Vesconite bearing.

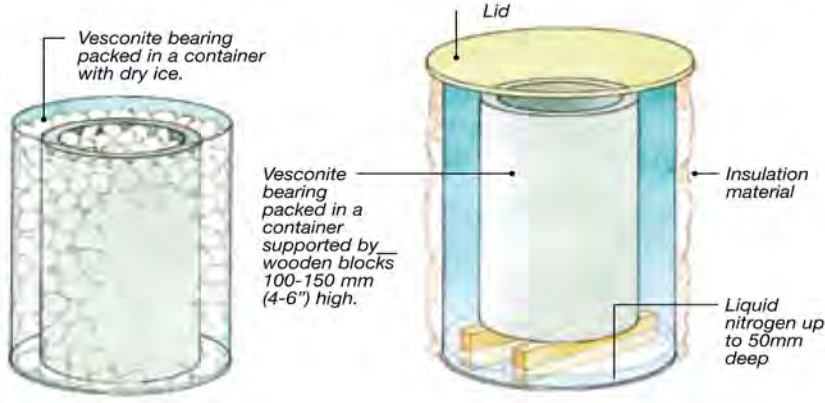

**Mechanical securing:** Various mechanical securing methods may be used to stop rotation and axial migration. Operation of Vesconite bearings above 70°C (160°F) may result in loosening of the press fit. Split the bearing and secure.

**Bonding:** Use an epoxy, Loctite or other suitable bonding agents for metal on plastics.

**Keeper plates:** Take care that no excessive pressure is placed on the bearing.

**Grub or locating screws:** The Vesconite bearing should be drilled to accept the grub screw. Ensure that grub screws are suitably bonded or secured into their threads.

**Flanged bearings secured with bolts** allow for easy installation and removal of the bearing.

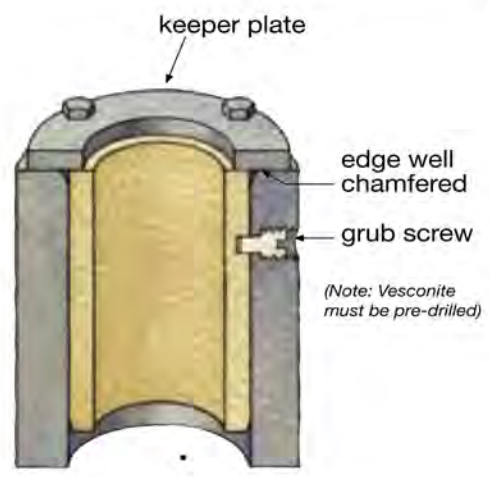

# Housings and shafts

## Shaft materials

Metal mating surfaces must suit the media and wear conditions encountered. When operating in sandy or abrasive conditions, hard shaft surfaces ensure longer shaft as well as bearing life.

Hardchrome plated surfaces are ideal.

As a general rule, the harder the shaft surface, the better the results that will be achieved with Vesconite bearings.

Shaft hardnesses of Rc > 50 are ideal.

However, the hardness of a 316 stainless steel is usually acceptable.

Corrosion resistant stainless steels and admiralty and gunmetal bronze

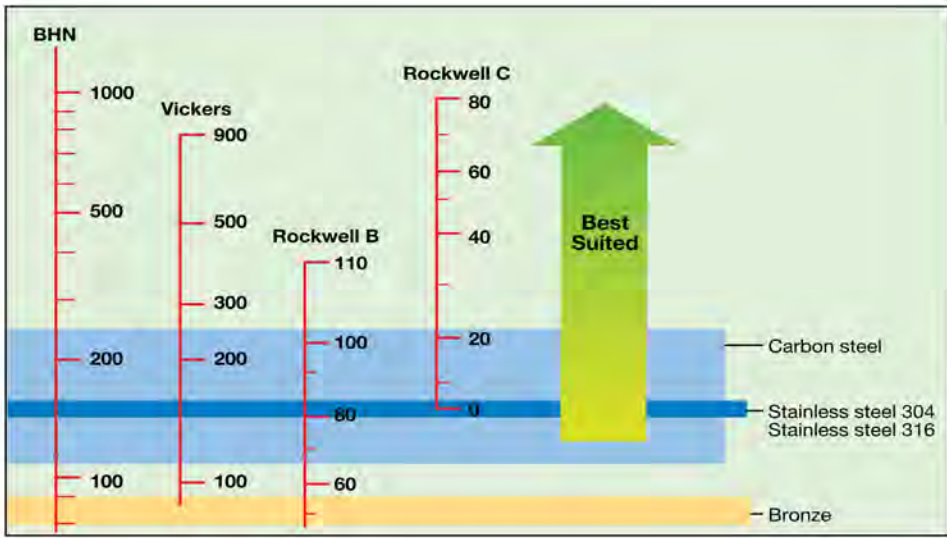

liners are generally satisfactory as mating surfaces for Vesconite.

Carbon steel and hardened steel shafts may be used as mating surfaces provided they do not corrode under the conditions of use.

## Machining tolerances

Standard ISO machining tolerances of H7 for metal housings and h7 for shafts are recommended for Vesconite bearings.

Since synthetic materials such as Vesconite and Vesconite Hilube have a wider tolerance specification, metal mating surfaces machined to closer tolerances than this standard are seldom required.

## Housing / shaft diameter tolerances in mm (ISO tolerances)

Diameter in mm			10 - 18	18 - 30	30 - 50	50 - 80	80 - 120	120 - 180	180 - 250	250 - 315
Housing	H7	Upper	+0.018	+0.021	+0.025	+0.030	+0.035	+0.040	+0.046	+0.052
		Lower	+0	+0	+0	+0	+0	+0	+0	+0
Shaft	h7	Upper	-0	-0	-0	-0	-0	-0	-0	-0
		Lower	-0.018	-0.021	-0.025	-0.030	-0.035	-0.040	-0.046	-0.052

## Housing / shaft diameter tolerances in inches

Diameter in inches			0.4 - 0.7	0.7 - 1.2	1.2 - 2.0	2.0 - 3.15	3.15 - 4.72	4.72 - 7.1	7.1 - 10.0	10.0 - 12.4
Housing	H7	Upper	+0.000 71	+0.000 83	+0.001 0	+0.001 2	+0.001 4	+0.001 6	+0.001 8	+0.002 1
		Lower	+0	+0	+0	+0	+0	+0	+0	+0
Shaft	h7	Upper	-0	-0	-0	-0	-0	-0	-0	-0
		Lower	-0.000 71	-0.000 83	-0.001 0	-0.001 2	-0.001 4	-0.001 6	-0.001 8	-0.002 1

## Surface finishes of shafts



The surface finish of the shaft is important to ensure long bearing life. Rough surface finishes and corroded and scored shafts will cause accelerated wear of Vesconite bearings and should be avoided.

A recommended ground finish of 0.5 µm Ra (0.002 microinch Ra) is ideal. Shaft roughness

	N10	N9	N8	N7	N6	N5	N4	N3	N2
Milling									
Boring, turning									
Grinding									
Polishing									
Micron R <sub>a</sub>	12.5	6.3	3.2	1.6	0.8	0.4	0.2	0.1	0.05
Microninch	500	250	125	63	32	16	8	4	2

should not exceed 2.5 µm Ra (0.010 microinch Ra).

For solid drawn shafts which have axial tool marks, roughness should be less than 0.5 µm Ra (0.002 microinch Ra).

Shafts should be round and not oval.

Where shafts with a tendency to corrosion cannot be avoided, Hitemp 150 may be considered as a possible solution.

# Machining Tolerances

Vesconite can be machined on standard machining equipment.

Bearings that are long (length greater than diameter) or have thin walls require additional care.

It is usually best to specify an outside diameter tolerance and a wall thickness tolerance, reducing the risk of the stacking of tolerances.

Where fine tolerances are required first fit the Vesconite into the casing and then machine to size.

## Suggested Vesconite machining tolerances are:

	Standard	Minimum	
		mm	inches
Outside diameter tolerance	± 0.1%	± 0.025	0.001
Inside diameter tolerance	± 0.1%	± 0.025	0.001
Wall thickness tolerance	+ 0.0 / -0.5%	+ 0.0 / -0.025	0.0 / -0.001
Length tolerance	+ 0.0 / -0.5%	+ 0.0 / -0.3	+ 0.0 / -0.01

## Temperature Compensation

The bearing dimensions calculated above assume measurement of the bearing at 20°C (70°F). If there is a large variance between the actual machining and operating temperatures, the resulting difference in size could result in incorrect bearing operation or premature failure.

Sizes need to be adjusted to the machining temperature to ensure that they are the correct size at operational temperatures.

## Machining guidelines for Vesconite

Vesconite and Vesconite Hilube are easily machined to fine tolerances on standard metal working equipment. Vesconite should not be clamped like a metal, but should be clamped carefully to avoid distortion. Cooling water should be used where possible to cool the cutting surface. Take cuts no more than 2 mm (0.1") deep at a time. Allow the bush to cool before taking the final cut.

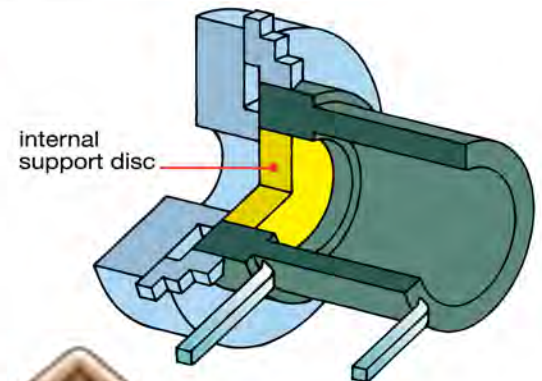

## Cutting angles

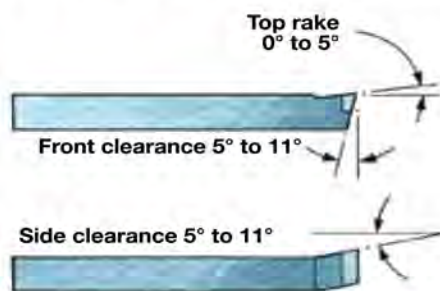



## Cutting speeds - Maximum of 300 m/min (1000 fpm)

Diameter mm	< 50	50-100	100-150	150-200	200-250	250-300	300-400	400-500
Diameter inches	< 2"	2-4"	4-6"	6-8"	8-10"	10-12"	12-16"	16-20"
RPM	600-2000	500-600	450	350	240	240	160	120

**Cutting feeds** *Finish turning:* 0,3 – 0,4 mm per revolution      0.012" – 0,016" per revolution

# Chemical resistance chart

-  Resistant
-  Partly resistant
-  Non-resistant

Resistance at 25°C (77°F) for Vesconite and Vesconite Hilube.

This chemical resistance chart is given as a guide only for the concentrations noted.

The aggressiveness of chemical solutions generally increases with higher concentrations and temperatures. While general guidelines may be provided, every application needs to be considered individually.

It is recommended to check the resistance in practical field tests in the solutions and temperatures in question.

Chemical Name	%	
Acetaldehyde		
Acetic acid	10	
Acetic acid	100	
Acetic anhydride		
Acetone		
Acetonitrile		
Acetophenone		
Acetyl chloride		
Aluminium chloride	10	
Aluminium sulphate	50	
Ammonia	Conc	
Ammonium hydroxide	10	
Ammonium sulfate	50	
Amyl acetate		
Amyl alcohol		
Aniline		
Anti freeze		
Aqua regia		
ASTM Oils		
Barium chloride		
Barium salts		
Benzaldehyde		
Benzene		
Benzyl alcohol		
Benzyl chloride		
Bleaching lye		
Bleaching solution		
Boric acid		
Brake fluid		
Bromine		
Butane		
Butanol		
Butyl acetate		
Butyl amine		
Butyl chloride		
Butyric acid		
Calcium chloride		
Calcium hypochlorite		
Calypsol greases		
Carbon disulphide		
Carbon tetrachloride		
Caster oil		
Cellosolve		
Chloride of lime		
Chlorine (gas-dry)		
Chlorine dioxide		
Chlorine in water		

Chemical Name	%	
Chloroacetic acid		
Chlorobenzene		
Chloroform		
Chlorosulfonic acid		
Chromic acid	40	
Citric acid	10	
Copper sulphate		
Cottonseed oil		
Cresol		
Cyclohexane		
Cyclohexanol		
Cyclohexanone		
Decalin		
Detergents	25	
Dibutyl phthalate		
Diesel		
Diethyl ether		
Diethylene amine		
Diethylene glycol		
Dimethyl formamide		
Diocetyl phthalate		
Dioxane		
Ethanol		
Ether		
Ethyl acetate		
Ethyl alcohol		
Ethyl chloride		
Ethylene dichloride		
Ethylene glycol		
Ferric chloride		
Fixer solution		
Fluorine (gas)		
Formaldehyde		
Formic acid	10	
Formic acid	90	
Freon		
Furfural		
Gasoline		
Glycerine		
Glycerol		
Glycol		
Grease		
Heptane		
Hexane		
High octane petrol		
Hydrobromic acid	50	
Hydrochloric acid	36	

Chemical Name	%	
Hydrochloric acid	100	
Hydrofluoric acid	5	
Hydrofluoric acid	40	
Hydrofluoric acid	50	
Hydrogen peroxide	35	
Hydrogen sulfide (gas)		
Ink		
Iodoacetic acid		
Isopropanol		
Kerosene		
Linseed oil		
Lubricating oil		
Magnesium chloride		
Methanol		
Methyl alcohol		
Methyl ethyl ketone		
Methyl glycol		
Methylene chloride		
Mineral oils		
n-Hexane		
Nickel chloride		
Nitric acid	10	
Nitric acid	40	
Nitrobenzene		
Octane		
Oil of cloves		
Oleic acid	100	
Olive oil		
Oxalic acid		
Ozone (gas)		
Paraffin		
Perchloroethylene		
Petrol		
Phenol		
Potassium bichromate	10	
Potassium bromide		
Potassium carbonate		
Potassium chloride	10	
Potassium dichromate	10	
Potassium hydroxide	1	
Potassium hydroxide	10	
Potassium hydroxide	60	
Potassium permanganate	25	
Potassium sulphate		
Propane		
Propanol		
Propyl alcohol		

Chemical Name	%	
Pyridine		
Rapeseed oil		
Silicone fluids		
Silver nitrate		
Soap solutions	1	
Sodium bicarbonate	10	
Sodium borate		
Sodium carbonate	20	
Sodium chloride	25	
Sodium hydroxide	1	
Sodium hydroxide	10	
Sodium hydroxide	60	
Sodium hypochlorite	20	
Sodium nitrate	10	
Stannic chloride		
Stearic acid		
Sucrose		
Sulfur dioxide (gas)		
Sulfuric acid	10	
Sulfuric acid	70	
Sulfuric acid	96	
Tea		
Tetrahydrofurane		
Tetralin		
Toluene		
Transformer oil		
Trichloroacetic acid		
Trichloroethane		
Trichloroethylene		
Tricresyl phosphate		
Triethanol amine		
Triethylene glycol		
Turbo oil		
Turpentine		
Urea		
Vaseline		
Vegetable oils		
Vinyl chloride		
Water		
Water (sea)		
Wine		
Xylene		
Zinc chloride		
Zinc sulfate		

## Stock availability

A large range of Vesconite and Vesconite Hilube stock shapes are available worldwide for machining pump bearings. Vesconite and Vesconite Hilube can be supplied as standard stock shapes at short notice or as final machined custom components.

## Tubes / bushings

Stocked in 1 meter (39") lengths for shafts from up to 650 mm (26") diameter in a large range of standard sizes.

Vesconite –  
More than 150 bushing sizes

Vesconite Hilube –  
More than 50 bushing sizes

## Rods

Stocked in 1 meter (39") lengths in diameters from 8 to 160 mm ( $\frac{5}{16}$ " to 6").

## Plates

Stocked in widths up to 600 mm (23") wide and 75 mm (3") thick. Ideal for machining large diameter wear rings.

## Moulded parts

Pump bearings can be injection moulded into finished or semi-finished form for cost effective solutions on larger quantity requirements.



## Disclaimer

This design manual is based upon many years of experience of VescoPlastics and VescoPlastics Sales (the Companies) in manufacturing and designing polymeric bearing materials.

Experience shows that no two applications are the same in every detail so the Companies encourage that every application be treated as individual and unique.

This information is offered in good faith as part of our client service, but favourable results cannot be guaranteed. This information is intended for use by persons with technical skill, at their discretion and risk. The purchaser must determine the suitability of the goods for their intended purpose.







The Companies reserve the right to change or amend any recommendation or specification without notice.

Goods are supplied on the express condition that the Companies' liability is limited to the replacement of defective goods or materials.

The Companies do not hold themselves responsible for any damage, incidental or consequential loss suffered as a result of the use of goods supplied.

Acceptance of goods will be held to imply agreement to the above conditions.

# Application assessment or quotation

 <p><b>Axial flow / mixed flow</b></p> <p><input type="checkbox"/> LINESHAFT  <input type="checkbox"/> Pump bowl  <input type="checkbox"/> Stuffing box  <input type="checkbox"/> Suction cover</p>	 <p><b>Sump</b></p> <p><input type="checkbox"/> Impeller support  <input type="checkbox"/> Shaft support  <input type="checkbox"/> Wear ring</p>	 <p><b>Centrifugal</b></p> <p><input type="checkbox"/> Wear ring  <input type="checkbox"/> Support bearing</p>
 <p><b>Split case</b></p> <p><input type="checkbox"/> Wear ring  <input type="checkbox"/> Support bearing  <input type="checkbox"/> LANTERN ring</p>	 <p><b>Submersible</b></p> <p><input type="checkbox"/> LINESHAFT  <input type="checkbox"/> Upthrust ring</p>	 <p><b>In line</b></p> <p><input type="checkbox"/> Wear ring  <input type="checkbox"/> Support bearing</p>

Other (specify) .....

**Pumped product**     Water     Clean  
 Other (specify) .....     Dirty (specify) .....

**Bearing size**     mm     inches

Housing/casing diameter .....    Bearing length .....

Shaft/impeller diameter .....    Number of bearings .....

**Operational conditions**

Rotational speed (RPM) .....    Temperature range .....

**Current material used**

Bronze     Elastomer     Rubber     Cutlass     Other (specify) .....

**Lubrication**     Product     Water     GRease     Oil     None

**Contact details**

Company .....    Contact Name .....

E-mail .....    Website www .....

Address .....

Country .....    Postal / Zip code .....

Telephone + (    ) .....    Fax + (    ) .....



# Vesconite and Vesconite Hilube

The material of choice for water lubricated pump bearings

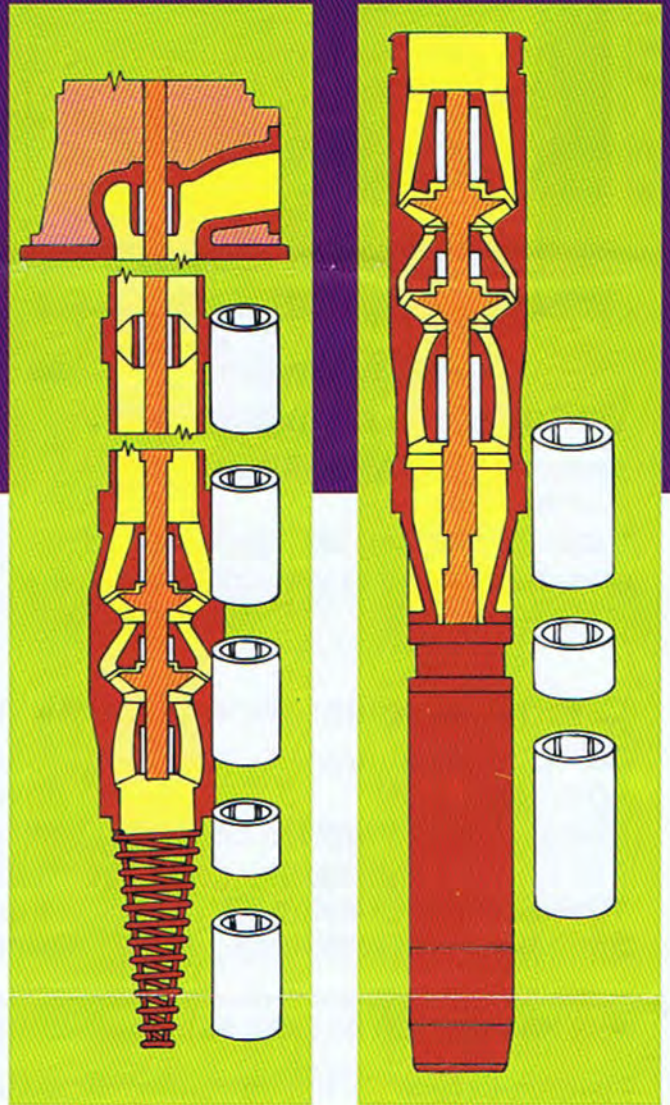
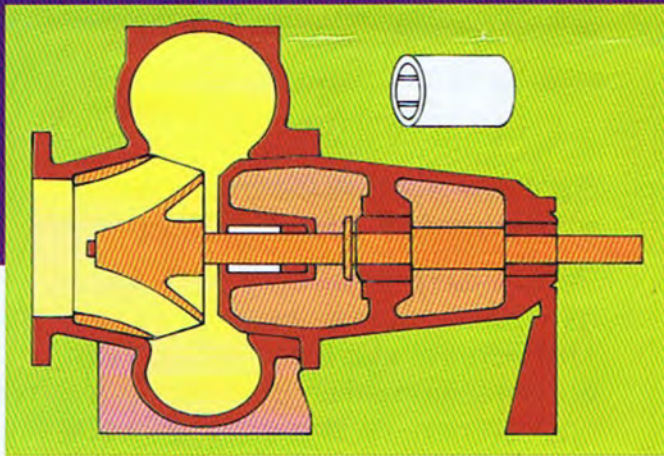

## What makes Vesconite special ?

- Dimensional stability. Vesconite does not swell or soften in water
- Low friction. Even when running dry
- Good chemical resistance
- Ease of machining

### Vesconite long life bearings for:

- Lineshaft bearings
- Pump bowl bearings
- Stuffing box bearings
- Wear rings
- Suction covers
- Lantern rings

vesconite.com VescoPlastics Metric Design-a-bush Calculator

#### Metric Design-a-bush Calculator for Pumps

Step 1 Fill in your dimensions, operating conditions and temperatures. Use the units specified in thousands separators and use a decimal point if required. Change initial values to those of your application.

Housing diameter (D)	<input type="text"/>	mm	Housing diameter must be > Shaft diameter If $d > 200$ mm, this is a large bush, and it will be checked by a consultant. Use Customer Service below.
Shaft diameter (d)	<input type="text"/>	mm	
Bush length (L)	<input type="text"/>	mm	
Total mass supported (M)	<input type="text"/>	kg	
No. of bushes supporting total mass (N)	<input type="text"/>		
Revolutions per min (R)	<input type="text"/>	rpm	
Max operating temp (Tmax)	<input type="text"/>	°C	If Tmax > 70 °C then please request your consultant. Use Customer Service below.
Min operating temp (Tmin)	<input type="text"/>	°C	
Scroll down for results ↓			<input type="button" value="Calculate"/>

↓ Drawing included ↓

Step 2 Check loading P =  MPa  
If P > 20MPa, this is a high bearing load a requirements and provide additional advice.

Step 3 Check shaft surface speed V =  m/min  
If V > 300 m/min, have your application of Customer Service below.  
If PV < 5 MPa.m/min, initial greasing or up to 10-20 MPa.m/min, regular greasing required.  
20-40 MPa.m/min, continuous lubrication.  
40-200 MPa.m/min, operate under water.  
If PV > 20 MPa.m/min, have your application of Customer Service below.

Step 4 Check PV =  MPa.m/min

# Vesconite and Vesconite Hilube

Water lubricated pump bearings  
Better performance for pumps

*There is no equivalent to  
Vesconite and Vesconite Hilube*

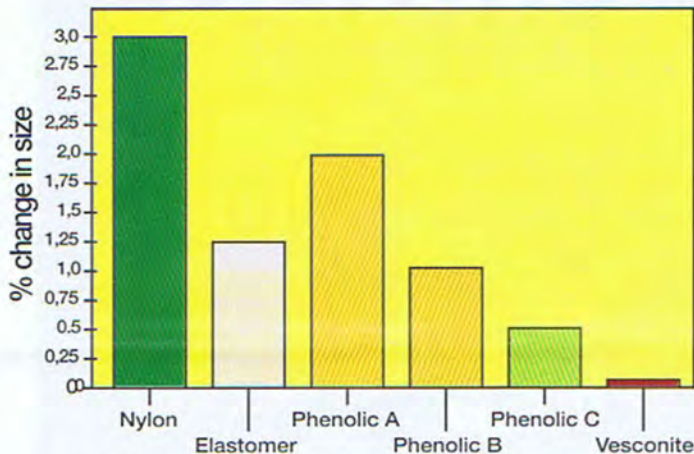

## Water swell comparison

Vesconite and Vesconite Hilube do not swell.  
Close tolerances can be achieved and maintained in wet conditions.

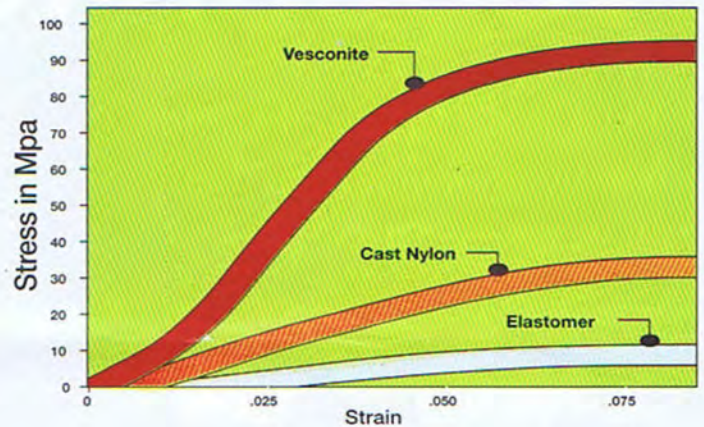

## Stress/Strain comparison after water absorption

Vesconite and Vesconite Hilube are high strength materials.  
They do not swell and lose their compression strength when in a moist environment or immersed in water.

## Chemical resistance (1 week at 20°C) unaffected by:

- |                                |                         |                 |
|--------------------------------|-------------------------|-----------------|
| 30% Sulphuric Acid             | 10% Sodium Hypochlorite | Transformer oil |
| 40% Nitric Acid                | 20% Hydrogen Peroxide   | Brake fluid     |
| Concentrated Hydrochloric Acid | Ethanol, Methanol       | Paraffin        |
| 1% Sodium Hydroxide            | Freon 11                | Gasoline        |
| 10% Sodium Chloride            | Butane and Heptane      | Anti-freeze     |
| 20% Sodium Carbonate           | Mineral Oils            |                 |